

Series



MOD Series
M Series
MC Series
MCS Series
VP Series
100 Series
S Series

- Operating voltages up to 13 kVDC
- Operating current 13 Amps / 30 Amps
- Ideal for internal cabling
- Quick assembly
- Several mounting options offering enhanced flexibility

General characteristics and technical data Series VarioPro CL

Electrical values	
Operating voltage (DC)	13 kV
Test voltage (DC)	20 kV

Housing	
Number of HV contacts	1 - 3
Insulation material	Thermoplast
Flammability class	UL94 V-0
Operating temperature	-40°C to +150°C
Insulating material group	I (DIN IEC 60664)

Contacts 1.6 mm	
Termination method	crimp
Rated current	13 A
Contact resistance	≤ 5 mΩ
Contact diameter	1.6 mm [.063"]
Wire size (AWG / cross section)	AWG 26 - 14 (0.14 - 2.5 mm ²)
Contact material	brass (CuZn)
Contact plating	silver (Ag), gold (Au)
Mating cycles	≥ 1,000
Rated temperature	+120°C

Suitable cable dimensions

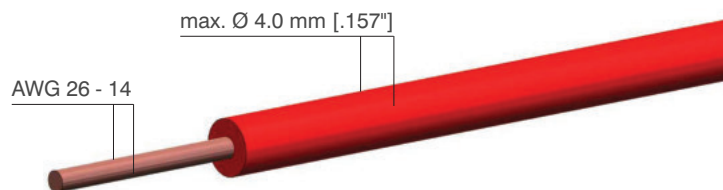

VarioPro CL1 - receptacle

Drawing

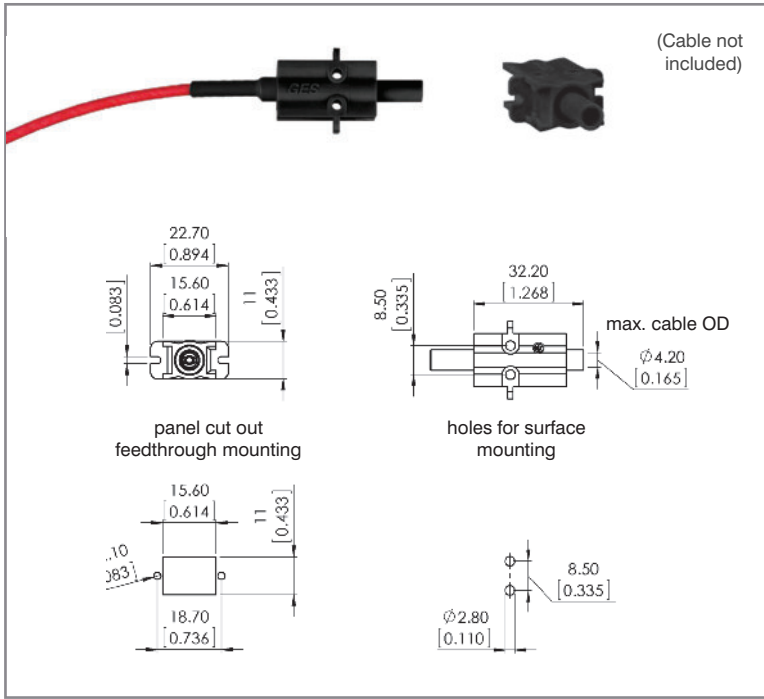

VarioPro CL1 - plug

Drawing

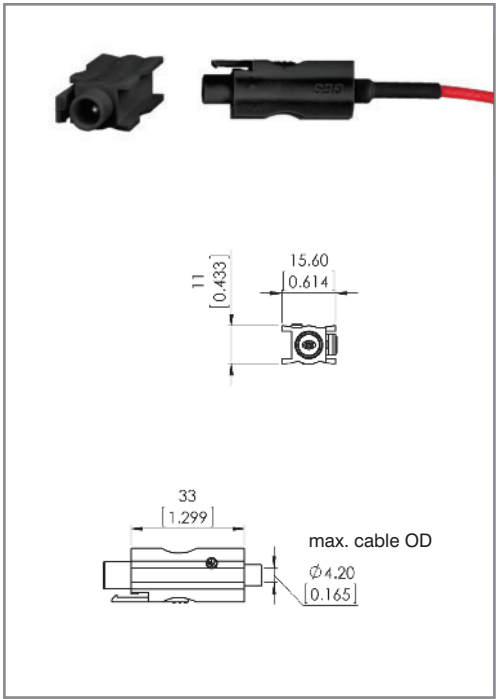

drawing - dimensions in mm [inch]

P/N	Description	Plug male contact	Receptacle female contact	Number of contacts	Including contacts	Contacts silver plated	Contacts gold plated
5000440	VP-CL-1HV-BU AWG 26 - 22 Ag		•	1	•	•	
5000441	VP-CL-1HV-BU AWG 20 Ag		•	1	•	•	
5000442	VP-CL-1HV-BU AWG 20 - 16 Ag		•	1	•	•	
5000443	VP-CL-1HV-BU AWG 16 - 15 Ag		•	1	•	•	
5000444	VP-CL-1HV-BU AWG 14 Ag		•	1	•	•	
5000445	VP-CL-1HV-BU AWG 26 - 22 Au		•	1	•		•
5000446	VP-CL-1HV-BU AWG 20 Au		•	1	•		•
5000447	VP-CL-1HV-BU AWG 20 - 16 Au		•	1	•		•
5000448	VP-CL-1HV-BU AWG 16 - 15 Au		•	1	•		•
5000449	VP-CL-1HV-BU AWG 14 Au		•	1	•		•
5000450	VP-CL-1HV-ST AWG 26 - 22 Ag	•		1	•	•	
5000451	VP-CL-1HV-ST AWG 20 Ag	•		1	•	•	
5000452	VP-CL-1HV-ST AWG 20 - 16 Ag	•		1	•	•	
5000453	VP-CL-1HV-ST AWG 16 - 15 Ag	•		1	•	•	
5000454	VP-CL-1HV-ST AWG 14 Ag	•		1	•	•	
5000455	VP-CL-1HV-ST AWG 26 - 22 Au	•		1	•		•
5000456	VP-CL-1HV-ST AWG 20 Au	•		1	•		•
5000457	VP-CL-1HV-ST AWG 20 - 16 Au	•		1	•		•
5000458	VP-CL-1HV-ST AWG 16 - 15 Au	•		1	•		•
5000459	VP-CL-1HV-ST AWG 14 Au	•		1	•		•

 **Cables and tools: page 69**

Type VarioPro CL

2-pole 13 kVDC

VarioPro CL2 - receptacle

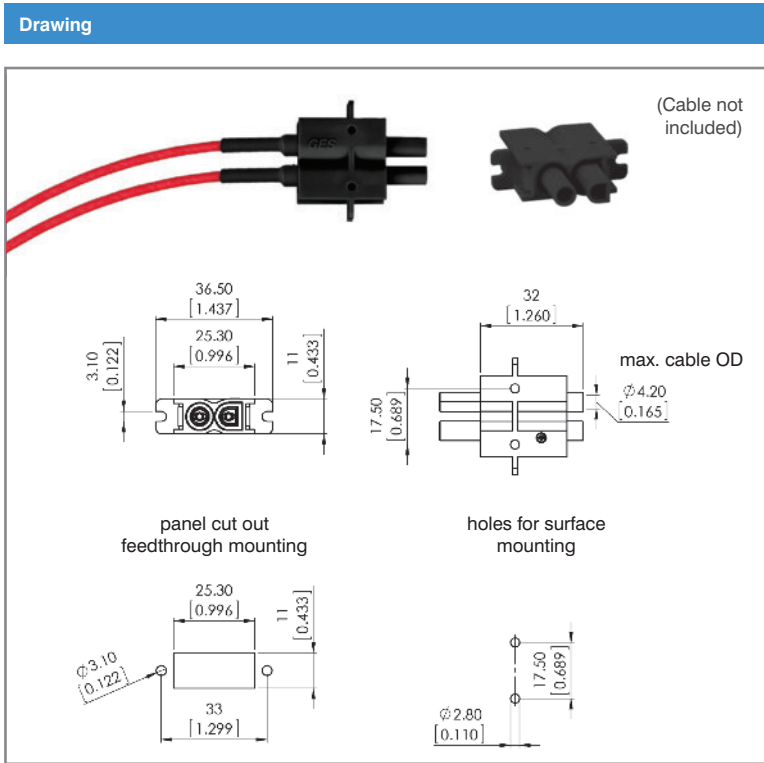

VarioPro CL2 - plug

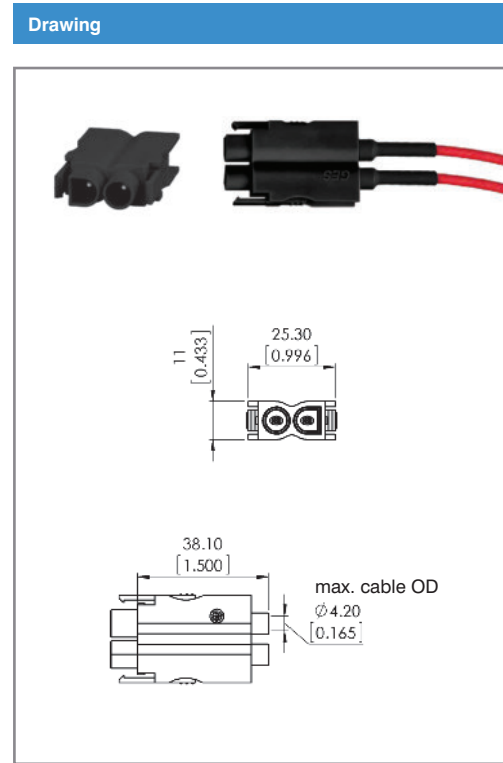

drawing - dimensions in mm [inch]

P/N	Description	Plug male contact	Receptacle female contact	Number of contacts	Including contacts	Contacts silver plated	Contacts gold plated
5000460	VP-CL-2HV-BU AWG 26 - 22 Ag		•	2	•	•	
5000461	VP-CL-2HV-BU AWG 20 Ag		•	2	•	•	
5000462	VP-CL-2HV-BU AWG 20 - 16 Ag		•	2	•	•	
5000463	VP-CL-2HV-BU AWG 16 - 15 Ag		•	2	•	•	
5000464	VP-CL-2HV-BU AWG 14 Ag		•	2	•	•	
5000465	VP-CL-2HV-BU AWG 26 - 22 Au		•	2	•		•
5000466	VP-CL-2HV-BU AWG 20 Au		•	2	•		•
5000467	VP-CL-2HV-BU AWG 20 - 16 Au		•	2	•		•
5000468	VP-CL-2HV-BU AWG 16 - 15 Au		•	2	•		•
5000469	VP-CL-2HV-BU AWG 14 Au		•	2	•		•
5000470	VP-CL-2HV-ST AWG 26 - 22 Ag	•		2	•	•	
5000471	VP-CL-2HV-ST AWG 20 Ag	•		2	•	•	
5000472	VP-CL-2HV-ST AWG 20 - 16 Ag	•		2	•	•	
5000473	VP-CL-2HV-ST AWG 16 - 15 Ag	•		2	•	•	
5000474	VP-CL-2HV-ST AWG 14 Ag	•		2	•	•	
5000475	VP-CL-2HV-ST AWG 26 - 22 Au	•		2	•		•
5000476	VP-CL-2HV-ST AWG 20 Au	•		2	•		•
5000477	VP-CL-2HV-ST AWG 20 - 16 Au	•		2	•		•
5000478	VP-CL-2HV-ST AWG 16 - 15 Au	•		2	•		•
5000479	VP-CL-2HV-ST AWG 14 Au	•		2	•		•



Cables and tools: page 69

VarioPro CL3 - receptacle

VarioPro CL3 - plug

Drawing

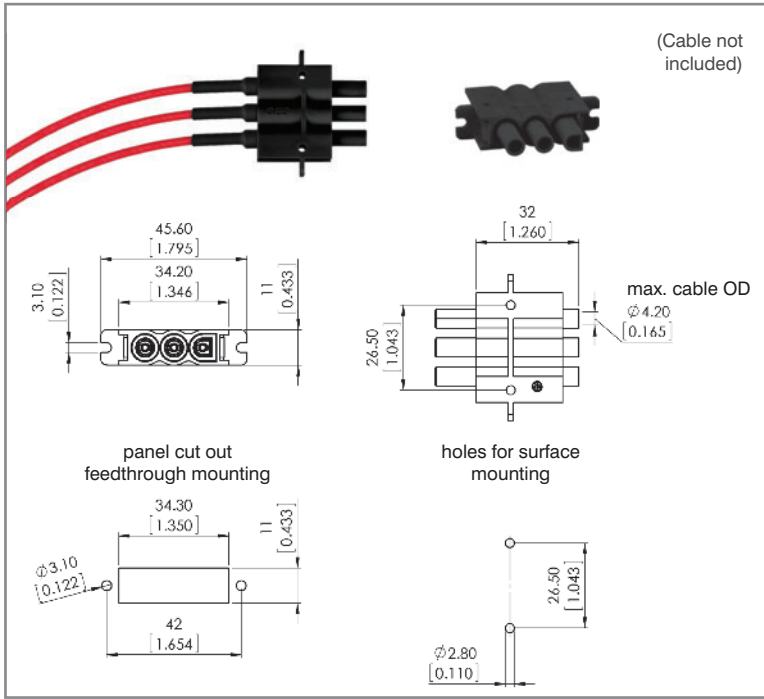

Drawing

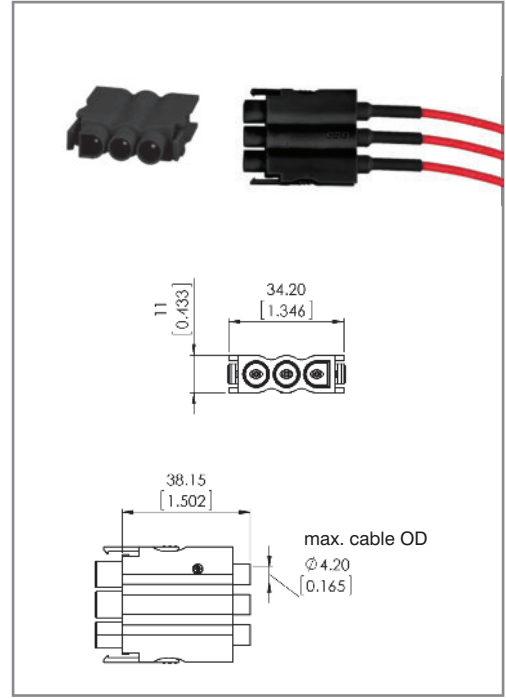

drawing - dimensions in mm [inch]

P/N	Description	Plug male contact	Receptacle female contact	Number of contacts	Including contacts	Contacts silver plated	Contacts gold plated
5000480	VP-CL-3HV-BU AWG 26 - 22 Ag		•	3	•	•	
5000481	VP-CL-3HV-BU AWG 20 Ag		•	3	•	•	
5000482	VP-CL-3HV-BU AWG 20 - 16 Ag		•	3	•	•	
5000483	VP-CL-3HV-BU AWG 16 - 15 Ag		•	3	•	•	
5000484	VP-CL-3HV-BU AWG 14 Ag		•	3	•	•	
5000485	VP-CL-3HV-BU AWG 26 - 22 Au		•	3	•		•
5000486	VP-CL-3HV-BU AWG 20 Au		•	3	•		•
5000487	VP-CL-3HV-BU AWG 20 - 16 Au		•	3	•		•
5000488	VP-CL-3HV-BU AWG 16 - 15 Au		•	3	•		•
5000489	VP-CL-3HV-BU AWG 14 Au		•	3	•		•
5000490	VP-CL-3HV-ST AWG 26 - 22 Ag	•		3	•	•	
5000491	VP-CL-3HV-ST AWG 20 Ag	•		3	•	•	
5000492	VP-CL-3HV-ST AWG 20 - 16 Ag	•		3	•	•	
5000493	VP-CL-3HV-ST AWG 16 - 15 Ag	•		3	•	•	
5000494	VP-CL-3HV-ST AWG 14 Ag	•		3	•	•	
5000495	VP-CL-3HV-ST AWG 26 - 22 Au	•		3	•		•
5000496	VP-CL-3HV-ST AWG 20 Au	•		3	•		•
5000497	VP-CL-3HV-ST AWG 20 - 16 Au	•		3	•		•
5000498	VP-CL-3HV-ST AWG 16 - 15 Au	•		3	•		•
5000499	VP-CL-3HV-ST AWG 14 Au	•		3	•		•

Cables and tools: page 69

Assembly Instructions Series VP ClipLock - plug

1.



Part as supplied
Shrinking tube (1), male contact (2),
connector shell (3)

5.



Slide contact (2) completely into connector shell (3) until contact snaps
☞ Pull gently to check that contact is correctly located and remains in position

2.



Place shrinking tube (1) on cable

6.



Slide shrinking tube (1) on connector shell (3)

3.



Remove dielectric insulation (L1 = 5-8 mm)

7.



Shrink tube - shrinking temperature 110°C

4.



Solder or crimp contact (2) on conductor
⚠ Please notice for soldering: Tin-solder must not remain on contact surface

8.



Assembly finished



Note – important!

1. Please carefully read assembly instructions before cable assembly.

2. Cable assembly must only be done by trained and qualified personnel.

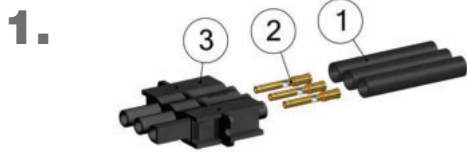

Part as supplied
Shrinking tube (1), female contact (2),
connector shell (3)

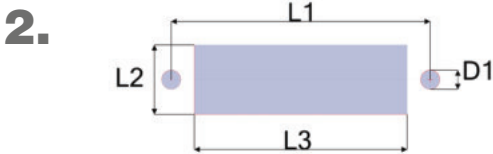

Panel cut out – feedthrough mounting

Type	D1 mm [inch]	L1 mm [inch]	L2 mm [inch]	L3 mm [inch]
VP-CL-1HV-BU	2.10 [.083"]	18.70 [.736"]	11.20 [.441"]	15.80 [.622"]
VP-CL-2HV-BU	3.10 [.122"]	33.00 [1.299"]	11.20 [.441"]	25.50 [1.004"]
VP-CL-3HV-BU	3.10 [.122"]	42.00 [1.654"]	11.20 [.441"]	34.50 [1.358"]



Panel cut out – surface mounting

Type	D2 mm [inch]	L4 mm [inch]
VP-CL-1HV-BU	2.80 [.110"]	8.50 [.335"]
VP-CL-2HV-BU	2.80 [.110"]	17.50 [.689"]
VP-CL-3HV-BU	2.80 [.110"]	26.50 [1.043"]

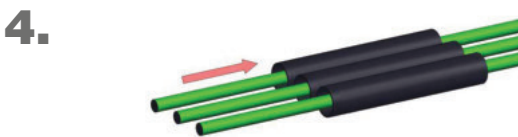

Place shrinking tube (1) on cable

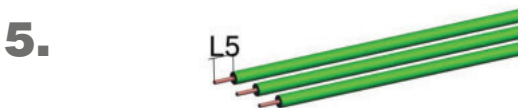

Remove dielectric insulation
(L5 = 5-8 mm [.197" - .315"])



Solder or crimp contact (2) on conductor
⚠ Please notice for soldering: Tin-solder must not remain on contact surface



Slide contact (2) completely into connector shell (3) until contact snaps
🗨 Pull gently to check that contact is correctly located and remains in position



Slide shrinking tube (1) on connector shell (3)



Shrink tubes - shrinking temperature 110°C



Assembly finished



Note – important!

1. Please carefully read assembly instructions before cable assembly.

2. Cable assembly must only be done by trained and qualified personnel.

General characteristics and technical data Series VarioPro Basic

Electrical values	
Operating voltage (DC)	8 kV
Test voltage (DC)	12 kV

Housing	
Number of HV-contacts	1 - 2
Insulation material	POM
Flammability class	UL94 HB
Operating temperature	-30°C to +120°C
Insulating material group	I (DIN IEC 60664)

Contacts 1.6 mm	
Termination method	crimp
Rated current	13 A
Contact resistance	≤ 5 mΩ
Contact diameter	1.6 mm [.063"]
Wire size (AWG / cross section)	AWG 26 - 14 (0.14 - 2.5 mm ²)
Contact material	brass (CuZn)
Contact plating	silver (Ag)
Mating cycles	≥ 1,000
Rated temperature	+120°C

Suitable cable dimensions

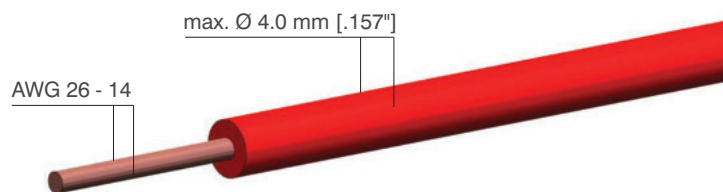

VarioPro Basic - receptacle, single pole (VP-1HV-BU)

Picture / Drawing

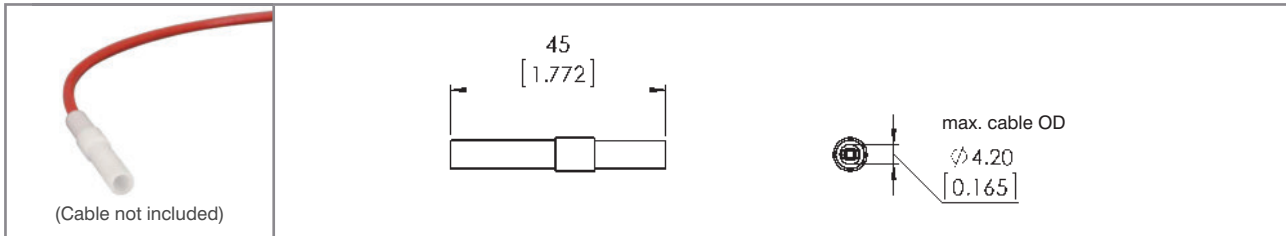

drawing - dimensions in mm [inch]

P/N	Description	Receptacle	Number of contacts	Including contacts	Panel mount
5000010	VP-1HV-BU POM AWG 26 - 22	•	1	•	•
5000011	VP-1HV-BU POM AWG 20	•	1	•	•
5000012	VP-1HV-BU POM AWG 20 - 16	•	1	•	•
5000013	VP-1HV-BU POM AWG 16 - 15	•	1	•	•
5000014	VP-1HV-BU POM AWG 14	•	1	•	•

VarioPro Basic - Stecker, 1-polig (VP-1HV-ST)

Picture / Drawing

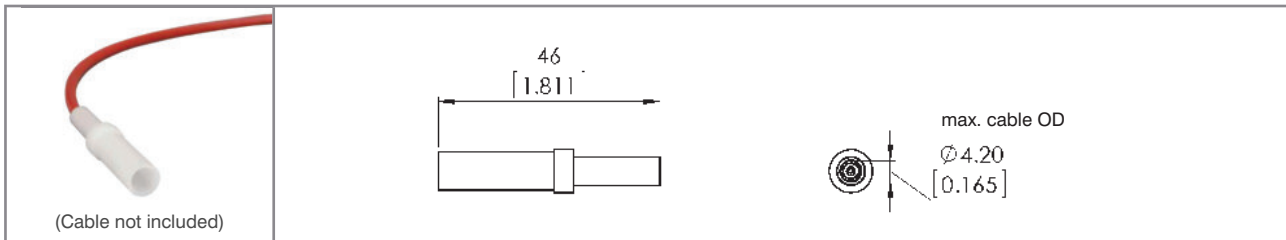

drawing - dimensions in mm [inch]

P/N	Description	Plug	Number of contacts	Including contacts	Panel mount
5000020	VP-1HV-ST POM AWG 26 - 22	•	1	•	•
5000021	VP-1HV-ST POM AWG 20	•	1	•	•
5000022	VP-1HV-ST POM AWG 20 - 16	•	1	•	•
5000023	VP-1HV-ST POM AWG 16 - 15	•	1	•	•
5000024	VP-1HV-ST POM AWG 14	•	1	•	•

 **Cables and tools:** page 69

Assembly Instructions Series VP

Basic - plug

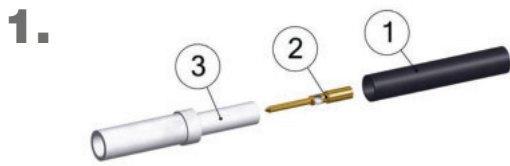

1.
Part as supplied
 Shrinking tube (1), male contact (2),
 connector shell (3)



5.
Slide contact (2) completely into connector shell (3) until contact snaps
 Pull gently to check that contact is correctly located and remains in position

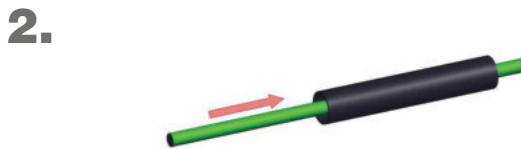

2.
 Place shrinking tube (1) on cable.



6.
 Slide shrinking tube (1) on connector shell (3)



3.
 Remove dielectric insulation (L1 = 5-8 mm
 [.197" - .315"])



7.
 Shrink tube - shrinking temperature 110°C



4.
Solder or crimp contact (2) on conductor
 Please notice for soldering: Tin-solder must not remain on contact surface



8.
 Assembly finished



Note – important!

1. Please carefully read assembly instructions before cable assembly.

2. Cable assembly must only be done by trained and qualified personnel.

Assembly Instructions Series-VP Basic - receptacle

1.

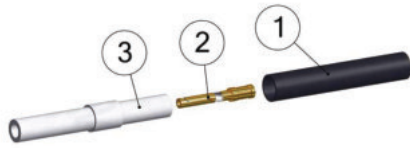

Part as supplied
Shrinking tube (1), female contact (2),
connector shell (3)

5.

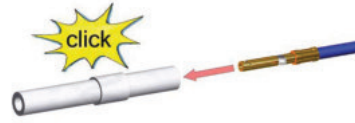

Slide contact (2) completely into connector shell (3) until contact snaps
☞ Pull gently to check that contact is correctly located and remains in position

2.



Place shrinking tube (1) on cable.

6.



Slide shrinking tube (1) on connector shell (3)

3.



Remove dielectric insulation (L1 = 5-8 mm)
[.197" - .315"]

7.



Shrink tube - shrinking temperature 110°C

4.

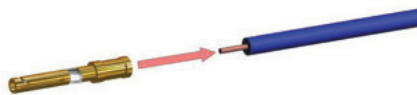

Solder or crimp contact (2) on conductor
⚠ Please notice for soldering: Tin-solder must not remain on contact surface

8.



Assembly finished



Note – important!

1. Please carefully read assembly instructions before cable assembly.

2. Cable assembly must only be done by trained and qualified personnel.

Type VarioPro Basic DF

1-pole 8 kVDC

VarioPro Basic DF (feedthrough) - receptacle, single pole (VP-DF-1HV-BU)

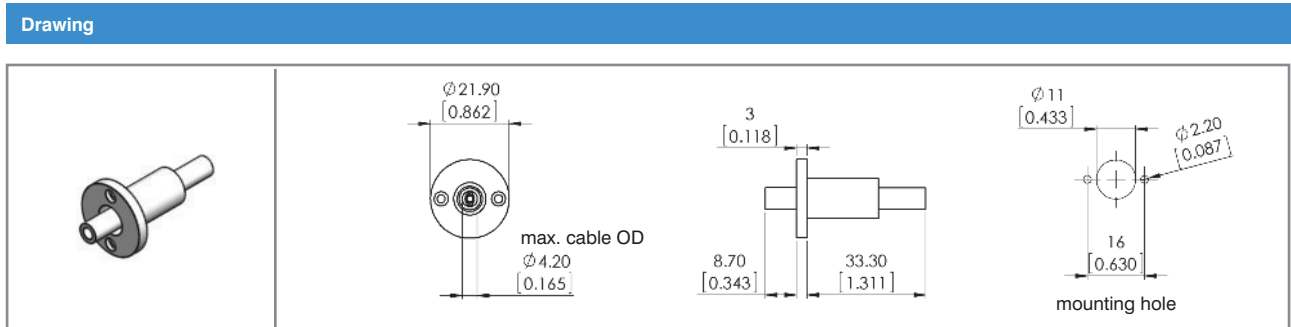

drawing - dimensions in mm [inch]

P/N	Description	Receptacle	Number of contacts	Including contacts	Panel mount
5000200	VP-DF-1HV-BU POM AWG 20 Ag	•	1	•	•
5000201	VP-DF-1HV-BU POM AWG 20 - 16 Ag	•	1	•	•
5000202	VP-DF-1HV-BU POM AWG 26 - 22 Ag	•	1	•	•
5000203	VP-DF-1HV-BU POM AWG 16 - 15 Ag	•	1	•	•
5000204	VP-DF-1HV-BU POM AWG 14 Ag	•	1	•	•

VarioPro Basic DF (feedthrough) - plug, single pole (VP-DF-1HV-ST)

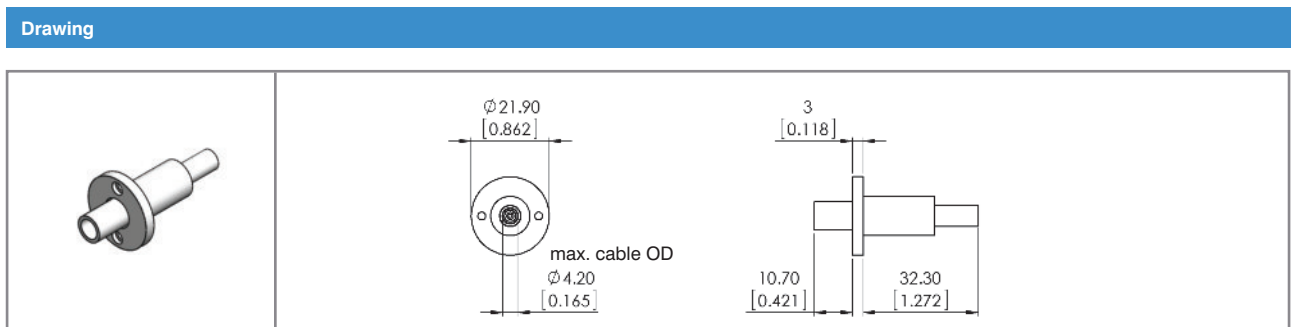

drawing - dimensions in mm [inch]

P/N	Description	Plug	Number of contacts	Including contacts	Panel mount
5000210	VP-DF-1HV-ST POM AWG 20 Ag	•	1	•	•
5000211	VP-DF-1HV-ST POM AWG 20 - 16 Ag	•	1	•	•
5000212	VP-DF-1HV-ST POM AWG 26 - 22 Ag	•	1	•	•
5000213	VP-DF-1HV-ST POM AWG 16 - 15 Ag	•	1	•	•
5000214	VP-DF-1HV-ST POM AWG 14 Ag	•	1	•	•

Possible combinations

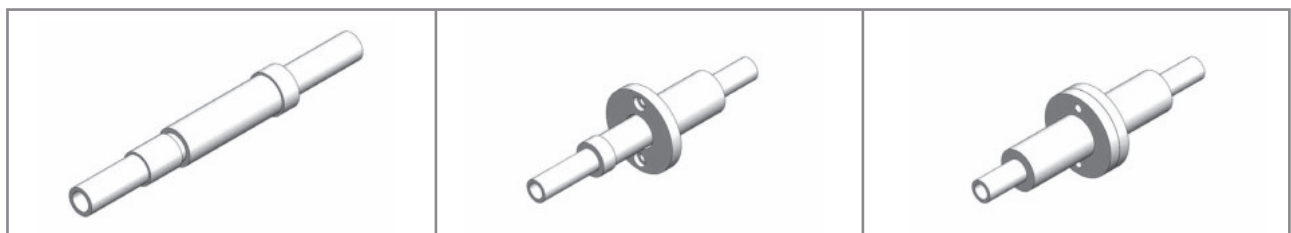

VarioPro Basic DF (feedthrough) - receptacle, 2-pole (VP-DF-2HV-BU)

Drawing

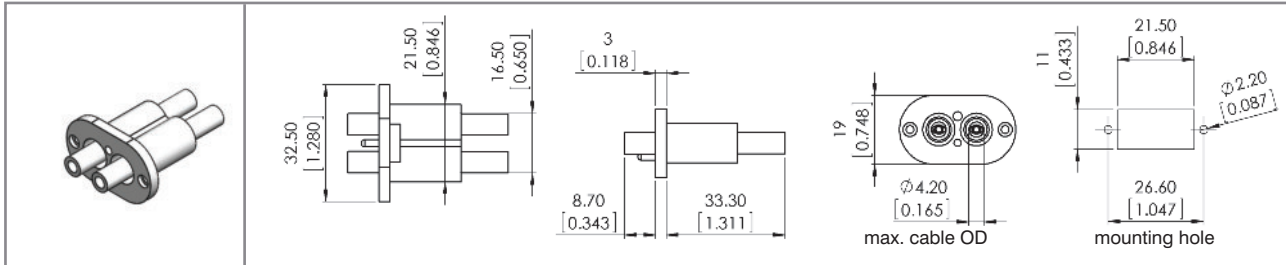

drawing - dimensions in mm [inch]

P/N	Description	Receptacle	Number of contacts	Including contacts	Panel mount
5000220	VP-DF-2HV-BU POM AWG 26 - 22 Ag	•	2	•	•
5000221	VP-DF-2HV-BU POM AWG 20 Ag	•	2	•	•
5000222	VP-DF-2HV-BU POM AWG 20 - 16 Ag	•	2	•	•
5000223	VP-DF-2HV-BU POM AWG 16 - 15 Ag	•	2	•	•
5000224	VP-DF-2HV-BU POM AWG 14 Ag	•	2	•	•

VarioPro Basic DF (feedthrough) - plug, 2-pole (VP-DF-2HV-ST)

Drawing

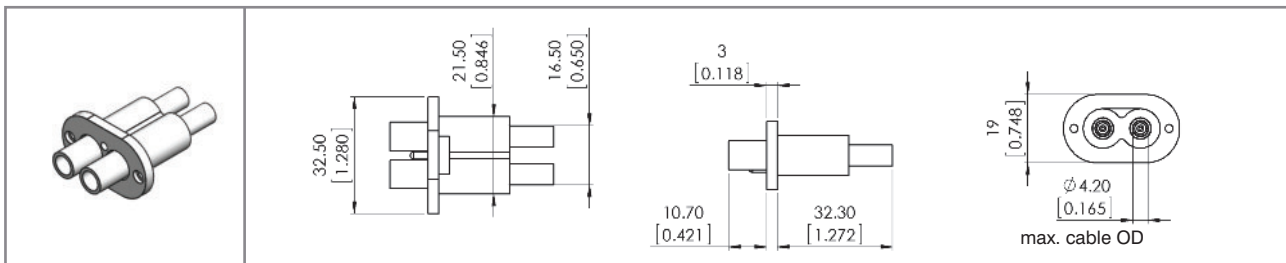

drawing - dimensions in mm [inch]

P/N	Description	Plug	Number of contacts	Including contacts	Panel mount
5000230	VP-DF-2HV-ST POM AWG 26 - 22 Ag	•	2	•	•
5000231	VP-DF-2HV-ST POM AWG 20 Ag	•	2	•	•
5000232	VP-DF-2HV-ST POM AWG 20 - 16 Ag	•	2	•	•
5000233	VP-DF-2HV-ST POM AWG 16 - 15 Ag	•	2	•	•
5000234	VP-DF-2HV-ST POM AWG 14 Ag	•	2	•	•

 **Cables and tools:** page 69

Assembly Instructions Series-VP Basic Feedthrough - plug

1.



Part as supplied

Shrinking tube (1), male contact (2), connector shell (3)

2.



Panel cut out

Type	D1 mm [inch]	L1 mm [inch]	L2 mm [inch]	L3 mm [inch]
VP-DF-2HV-ST	2.20 [.087"]	26.60 [1.047"]	11.20 [.441"]	21.70 [.854"]

3.



Place shrinking tube (1) on cable

4.



Remove dielectric insulation (L4 = 5-8 mm)
[.197" - .315"]

5.

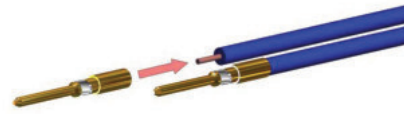

Solder or crimp contact (2) on conductor

⚠ Please notice for soldering: Tin-solder must not remain on contact surface

6.

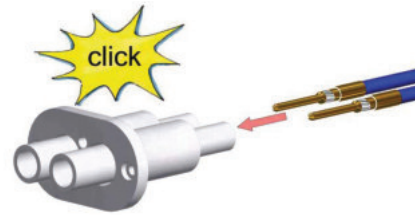

Slide contact (2) completely into connector shell (3) until contact snaps

🗨 Pull gently to check that contact is correctly located and remains in position

7.

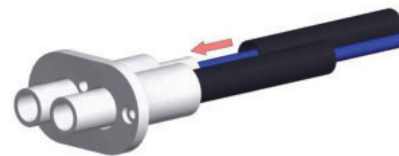

Slide shrinking tube (1) on connector shell (3)

8.



Shrink tubes - shrinking temperature 110°C

9.



Assembly finished

Assembly Instructions Series-VP Basic Feedthrough - receptacle

1.

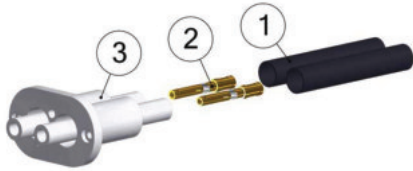

Part as supplied

Shrinking tube (1), female contact (2), connector shell (3)

2.

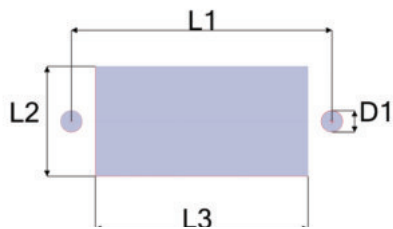

Panel cut out

Type	D1 mm [inch]	L1 mm [inch]	L2 mm [inch]	L3 mm [inch]
VP-DF-2HV-BU	2.20 [.087"]	26.60 [1.047"]	11.20 [.441"]	21.70 [.854"]

3.



Place shrinking tube (1) on cable

4.



Remove dielectric insulation (L4 = 5-8 mm)
[.197" - .315"]

5.



Solder or crimp contact (2) on conductor

⚠ Please notice for soldering: Tin-solder must not remain on contact surface

6.



Slide contact (2) completely into connector shell (3) until contact snaps

🗨 Pull gently to check that contact is correctly located and remains in position

7.

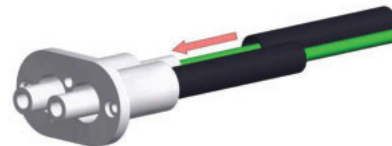

Slide shrinking tube (1) on connector shell (3)

8.



Shrink tubes - shrinking temperature 110°C

9.



Assembly finished

General characteristics and technical data Series VarioPro SB10

Electrical values	
Operating voltage (DC)	10 kV
Test voltage (DC)	15 kV

Housing	
Number of HV-contacts	1
Insulation material	POM / PTFE
Flammability class POM	UL94 HB
Flammability class PTFE	UL94 V-0
Operating temperature POM	-30°C to +120°C
Operating temperature PTFE	-50°C to +200°C
Insulating material group	I (DIN IEC 60664)

Contacts 2.7 mm	
Termination method	solder
Rated current	30 A
Contact resistance	≤ 300 mΩ
Contact diameter	2.7 mm [.106"]
Wire size (AWG / cross section)	AWG 14 (2.5 mm ²)
Contact material	brass (CuZn)
Contact plating	silver (Ag)
Mating cycles	≥ 100,000
Rated temperature	+120°C

Suitable cable dimensions

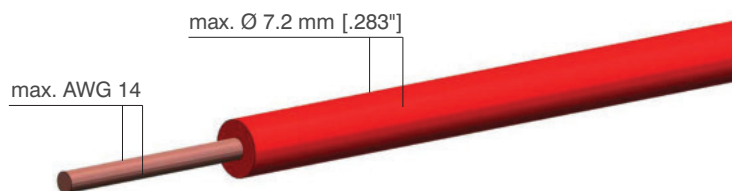

VarioPro Basic B10 - receptacle

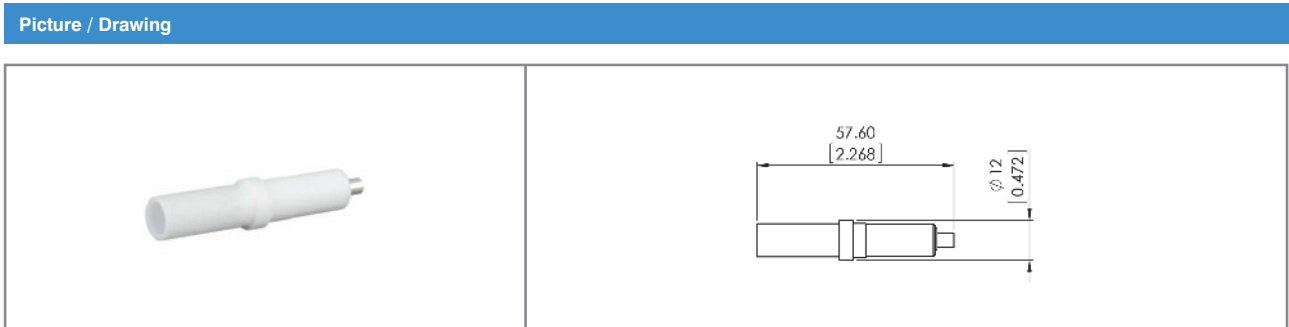

drawing - dimensions in mm [inch]

VarioPro Basic S10 - plug

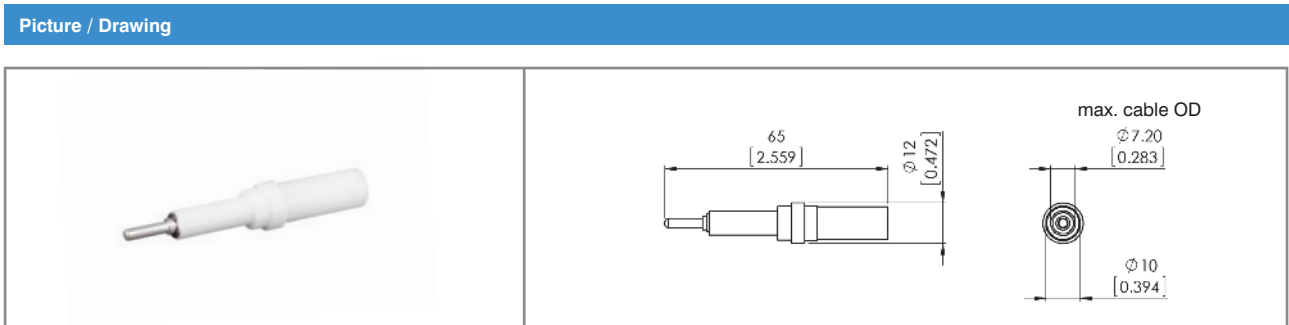

drawing - dimensions in mm [inch]

P/N	Description	Plug	Receptacle	Number of contacts	Including contacts	Contacts, silver plated
710000	S10 POM	•		1	•	•
710100	B10 POM		•	1	•	•
710200	S10 PTFE	•		1	•	•
710300	B10 PTFE		•	1	•	•

 **Cables and tools:** page 69

Single parts / Contacts for types VarioPro Clip Lock, Basic and Basic Feedthrough

Male contacts 1.6 mm

P/N	Description	Cross section in mm ² (D)	AWG (D)	Silver plated	Gold plated	Drawing
6575085	male contact 1.6 mm / AWG 26 - 22	0.14 - 0.37	26 - 22	•		
6575086	male contact 1.6 mm / AWG 20	0.5	20	•		
6575088	male contact 1.6 mm / AWG 20 - 16	0.75 - 1.0	20 - 16	•		
6575090	male contact 1.6 mm / AWG 16 - 15	1.5	16 - 15	•		
6575083	male contact 1.6 mm / AWG 14	2.5	14	•		
6575118	male contact AU 1.6 mm / AWG 26 - 22	0.14 - 0.37	26 - 22		•	
6575121	male contact AU 1.6 mm / AWG 20	0.5	20		•	
6575116	male contact AU 1.6 mm / AWG 20 - 16	0.75 - 1.0	20 - 16		•	
6575124	male contact AU 1.6 mm / AWG 16 - 15	1.5	16 - 15		•	
6575125	male contact AU 1.6 mm / AWG 14	2.5	14		•	







drawing - dimensions in mm [inch]

Female contacts 1.6 mm

P/N	Description	Cross section in mm ² (D)	AWG (D)	Silver plated	Gold plated	Drawing
6575095	female contact 1.6 mm / AWG 26 - 22	0.14 - 0.37	26 - 22	•		
6575107	female contact 1.6 mm / AWG 20	0.5	20	•		
6575098	female contact 1.6 mm / AWG 20 - 16	0.75 - 1.0	20 - 16	•		
6575100	female contact 1.6 mm / AWG 16 - 15	1.5	16 - 15	•		
6575084	female contact 1.6 mm / AWG 14	2.5	14	•		
6575127	female contact AU 1.6 mm / AWG 26 - 22	0.14 - 0.37	26 - 22		•	
6575131	female contact AU 1.6 mm / AWG 20	0.5	20		•	
6575117	female contact AU 1.6 mm / AWG 20 - 16	0.75 - 1.0	20 - 16		•	
6575132	female contact AU 1.6 mm / AWG 16 - 15	1.5	16 - 15		•	
6575133	female contact AU 1.6 mm / AWG 14	2.5	14		•	

drawing - dimensions in mm [inch]

Suitable cables for Series VP

Part No.	3330090	3330091	3330092	3330093	3330094	3330095	3330020
							
Operating voltage DC	15 kVDC						10 kVDC
Operating voltage AC rms	-						-
Conductor size							
AWG	AWG 24	AWG 22	AWG 20	AWG 18	AWG 16	AWG 14	AWG 14
Strands	19 x AWG 36	7 x AWG 30	10 x AWG 30	16 x AWG 30	26 x AWG 30	41 x AWG 30	50 x 0.25 mm
Cross section	0.24 mm ²	0.36 mm ²	0.51 mm ²	0.81 mm ²	1.32 mm ²	2.08 mm ²	2.5 mm ²
Diameter	0.55 mm	0.68 mm	0.81 mm	1.02 mm	1.30 mm	1.63 mm	1.78 mm
Dielectric insulation							
Diameter	2.7 mm	2.9 mm	3.0 mm	3.3 mm	3.5 mm	3.9 mm	3.8 mm
Material	silicone						silicone
Ozone and corona resistant	YES						-
UL	AWM Style 3239						-
Temperature rating	max. 150°C						-20°C to +180°C
Color	red*						black
Fits connector types	VarioPro Clip Lock 1-, 2-, and 3-pole VarioPro Basic VarioPro Basic Feedthroughs 1-, and 2-pole						

* Different colors available on request

Tools

Part No.	Description	Connector types
3000001	Extracting tool for contacts 1.6 mm - male and female	VP ClipLock, VP Basic
3000015	Crimping tool for contacts 1.6 mm - male and female incl. pliers, contact holder and crimping cheeks	VP ClipLock, VP Basic